

PRODUCT DATA

COMFORT 5000 BY NILAN



Ventilation & passive heat recovery



Commercial



Passive
heat recovery



Ventilation
< 5300 m³/h

COMFORT 5000

The Comfort 5000 is a ventilation unit suitable for central ventilation of residential buildings, schools, offices and business facilities with a ventilation requirement of up to 5300 m³/h.

Every component has been carefully selected with a view to unsurpassed quality and each component is tested throughout the entire production process, as are the finished units before leaving the factory. This quality control reflects our high standards, which not only exceed market requirements but also take them several steps further.

Automatic control

The Comfort 5000 is supplied with an integrated CTS 602 control, which is operated by the enclosed control panel.

The modern CTS 602 control communicates Modbus RTU RS485. A CTS system using this type of communication can easily be connected to the device.

Plug fans

The two fan sections consist of energy-efficient EC motors with built-in motor controllers operated by a 0-10V signal.

The efficient fan wheels have rear facing impellers and are extremely quiet.

Counterflow heat exchanger

Heat recovery is achieved by four counter flow heat exchangers made of highly corrosion resistant marine aluminium. The counterflow heat exchangers have an energy efficiency of more than 80% and prevent odours being transferred from the extracted air to the supply air.

The CTS 602 control allows for cooling recovery

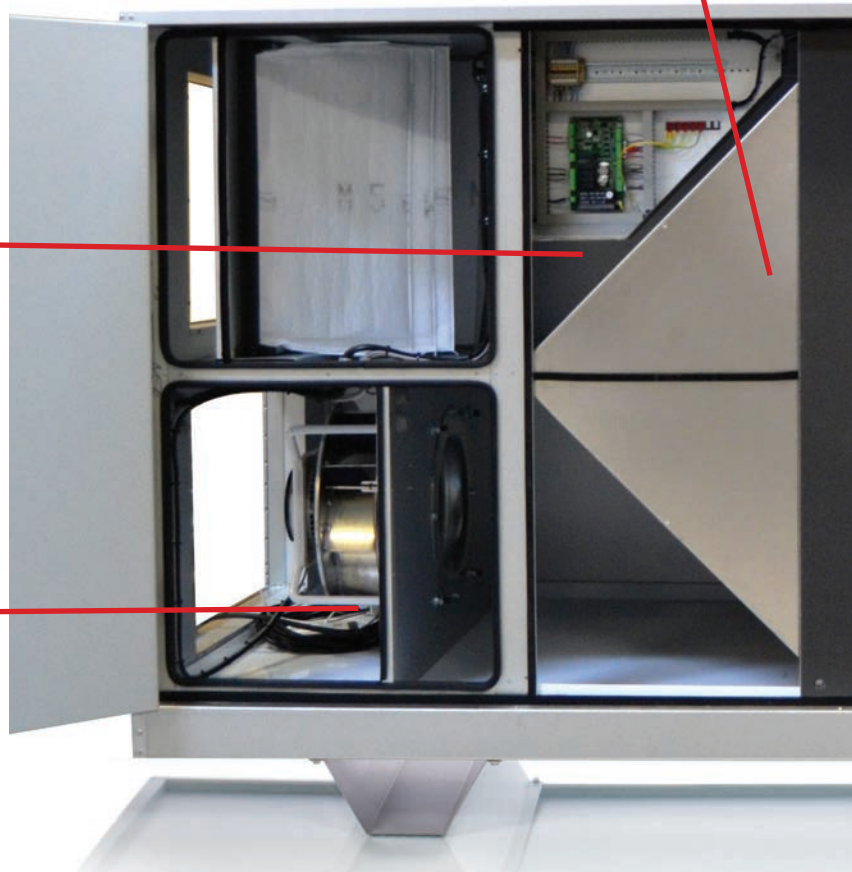

Doors

The large doors allow easy access for the changing the filters, as well as servicing of the unit.

The doors are mounted with lockable safety doorhandles.

Frost protection

An electric heater can be purchased for frost protection. This prevents the formation of ice in the counterflow heat exchanger in the event of long periods of frost.



Modulating 100% bypass

An automatic bypass valve directs the fresh air past the heat exchanger when waste heat recovery is not necessary, thus conserving energy.

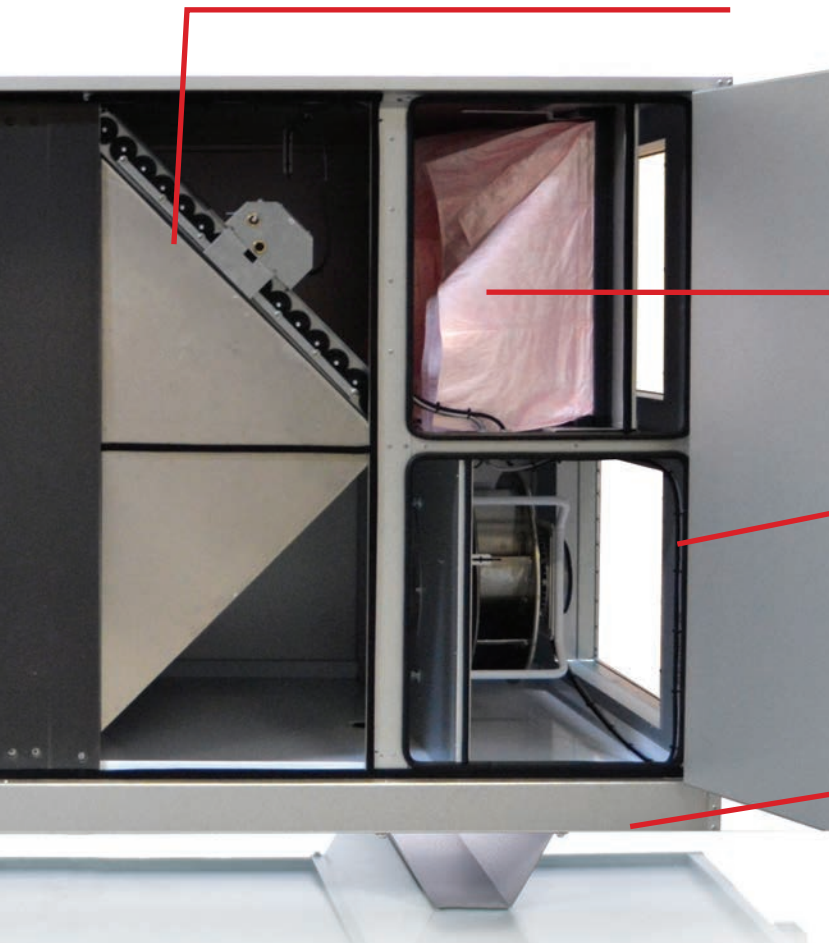

Filters

The Comfort 5000 is supplied with bag filters. An M5 filter in the air exhaust and an F7 filter for fresh air are supplied as standard.

The CTS 602 control has a built-in timer controlled alarm for change of filter. It is possible to install a pressure controlled filter monitor (accessory).

Construction

The Comfort 5000 is housed in a strong frame structure of Aluzinc with 50 mm insulation.

Base

Comfort 5000 is delivered with a robust built-in base. A foundation and vibration absorbers can be ordered as an accessory. This ensures a noiseless installation.

Heating elements

External water or electric heating elements, regulated by the CTS 602 control, can be purchased.

The water-heating surface can be built into the unit.

Pressure control

The extraction and/or supply fan can be operated with the aid of a pressure transmitter.



COMFORT 5000

Technical specifications

Dimensions (W x D x H)	2650 x 1250 x 1500 mm
Weight	617 kg
Min. Airvolume	500 m ³ /h
Max. Airvolume	5300 m ³ /h
Power consumption	3.9 kW
Power supply	3 x 400V, 50 Hz
Max. phase	3 x 13 A
Standby power	3 W
Plate type casing	Aluzinc steel plate
Heat exchanger type	Aluminium counterflow heat exchanger
Filter class	Standard bagfilters M5 Extract air and F7 Fresh air
Duct connections (WxH)	800 x 500 mm
Condensate drain	PVC, Ø 20x1.5 mm
External leakage underpressure (*1)	< 0,9 %
External leakage overpressure (*2)	< 0,9 %
Internal leakage (*3)	< 0,5 %
Tightness class	IP31

*1 At ± 250 Pa and 4000 m³/h according EN 13141-7.

*2 At ± 250 Pa and 4000 m³/h according EN 13141-7.

*3 At ± 100 Pa and 4000 m³/h according EN 13141-7.



Motor and motor control

Motor type	EC-Engine
Motor class in accordance with IEC 60034-30	IE3 (Premium efficiency)
Voltage input	1 x 230 V
Current overload protection	Built-in
Control signal with third party control system	0 - 10 V DC
Fluid temperature (air)	-20 / +40 °C
Ambient temperature (operating)	-20 / +40 °C

Data for ecodesign

Fan data	
Max. total efficiency (A-D)	67.9 %
ECO measurement set-up (A-D)	A
Efficiency level requirements	62N (2015)
ECO efficiency level during optimal operating point	75.3
Motor data (optimal operating point)	
EC-motor	With motor controller
Absorbed power	1.954 kW
Airflow	4863 m ³ /h
Total pressure	897 Pa
RPM during optimal operating point	2311

Conditions according with EC327/2011

Functional diagram

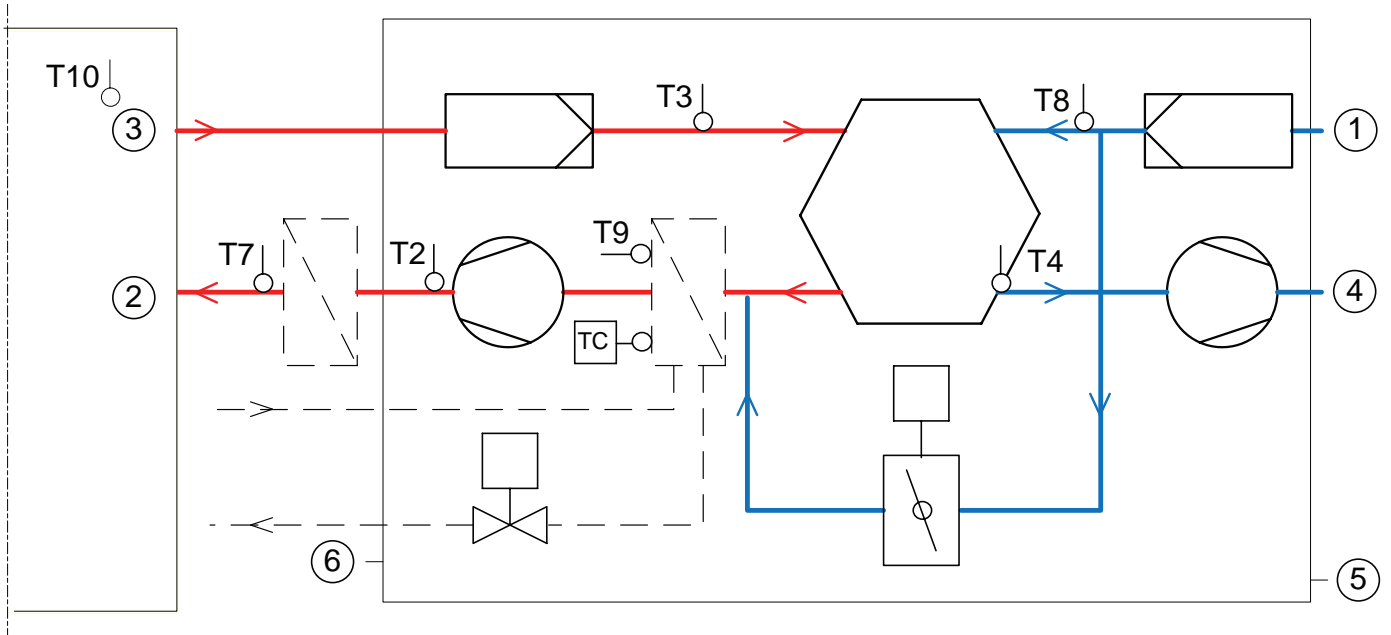

Connections

- 1: Fresh air
- 2: Supply air
- 3: Extract air
- 4: Discharge air
- 5: Condensate drain
- 6: Electric and water heating

Automation

- T2/T7: Supply air sensor
- T9/TC: Heating element frost protection
- T3: Extract air sensor
- T4: Discharge air and defrost sensor
- T8: Fresh air sensor
- T10: Room sensor

PLANNING DATA

Nilan units are tested in accordance with the valid standards of accredited independent test institutes.

Capacity

Capacity of standard unit as a function of q_v and $P_{t,ext}$.

SFP values according to EN 13141-7 are for standard units with M5-filter in extract air, F7-filter in fresh air and no heating element.

SFP values comprise the unit's total power consumption excl. control.

Conversion factor: $\frac{J/m^3}{3600} = W/m^3/h$

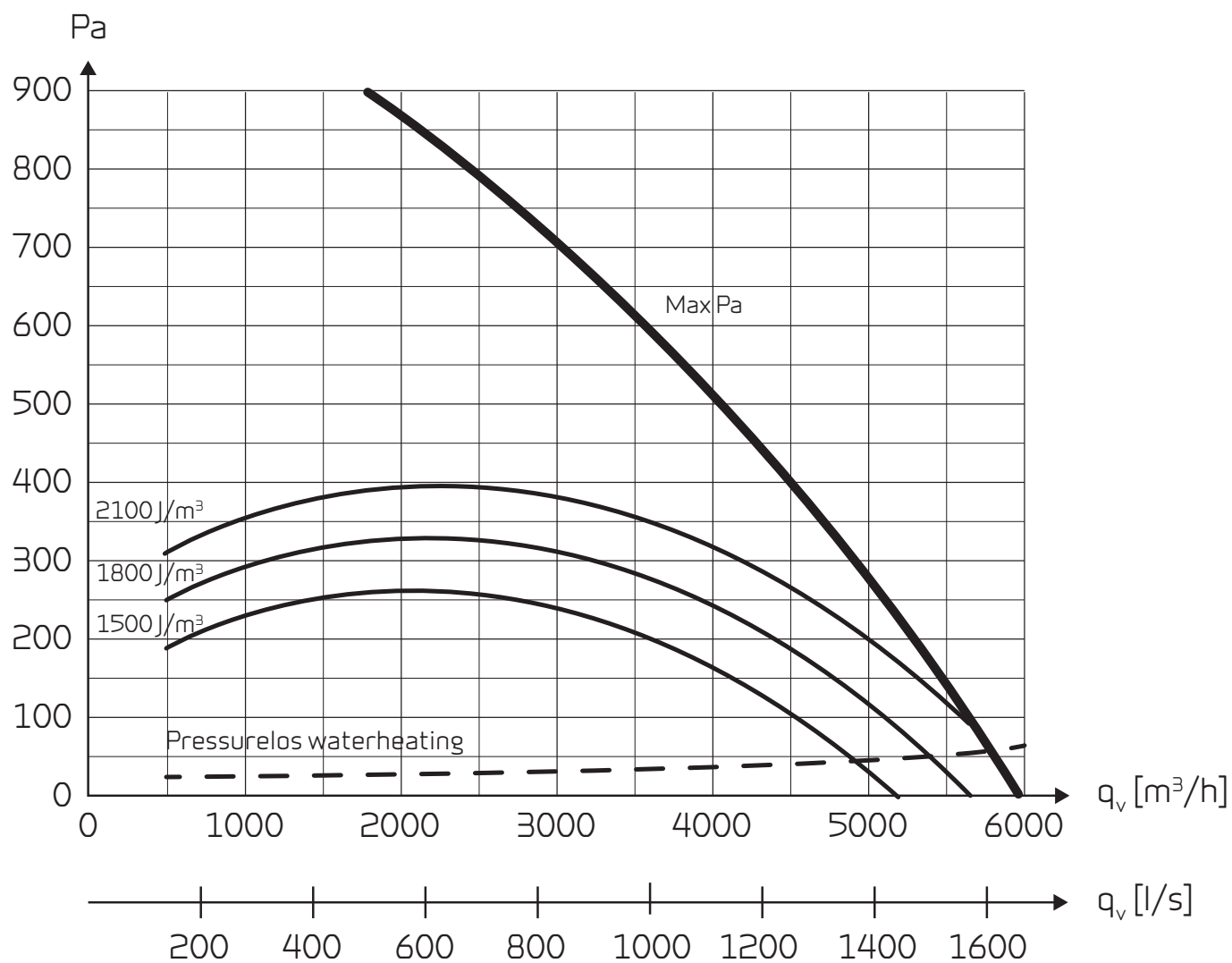

Temperature efficiency

Temperature efficiency for unit with counterflow heat exchanger according to EN308 (dry).

Temperature efficiency EN308: $\eta_t = (t_{\text{supply air}} - t_{\text{fresh air}}) / (t_{\text{extract air}} - t_{\text{fresh air}})$

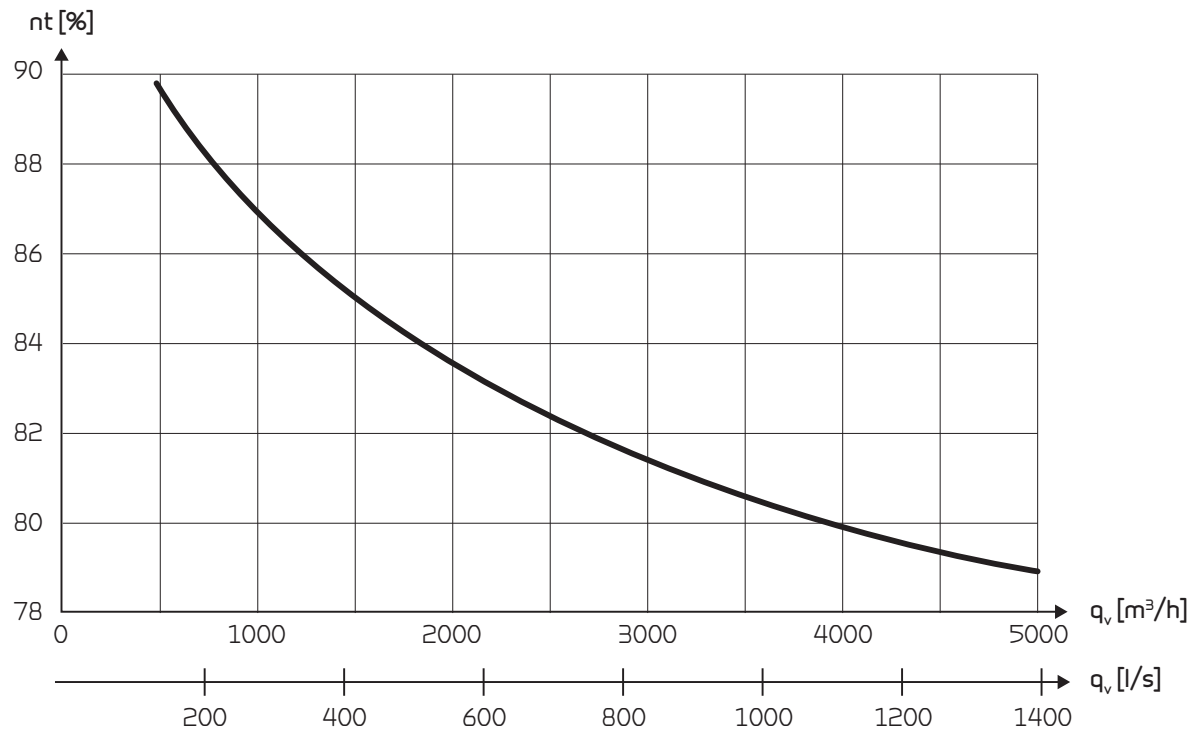

Sound data

Sound data for $q_v = 4000 \text{ m}^3/\text{h}$ and $P_{t, \text{ext}} = 100 \text{ Pa}$ according to EN 9614-2 for surfaces and EN 5136 for ducts.

Sound output level L_{WA} drops with falling air volume and falling back pressure.

Sound output level L_{pA} at a given distance will depend on acoustic conditions in the place of installation.

Sound output level (L_{WA})

Octave band Hz	Surface dB(A)	Supply air dB(A)	Extract air dB(A)	Outdoor air dB(A)	Discharge air dB(A)
125	47,7	61,4	48,7	50,4	60,2
250	50,6	70,1	57,5	59,9	68,5
500	44,9	78,3	54,2	56,7	75,7
1.000	43,7	81,5	53,7	56,4	79,8
2.000	35,7	75,6	47,3	48,8	74,1
4.000	30,9	70,4	33,6	35,4	68,0
8.000	23,2	59,6	14,9	14,6	54,3
Total $\pm 2 \text{ dB(A)}$	53,7	84,3	60,8	63,2	82,4

PLANNING DATA

Heating elements (accessory)

Water heating element (for internal fitting)

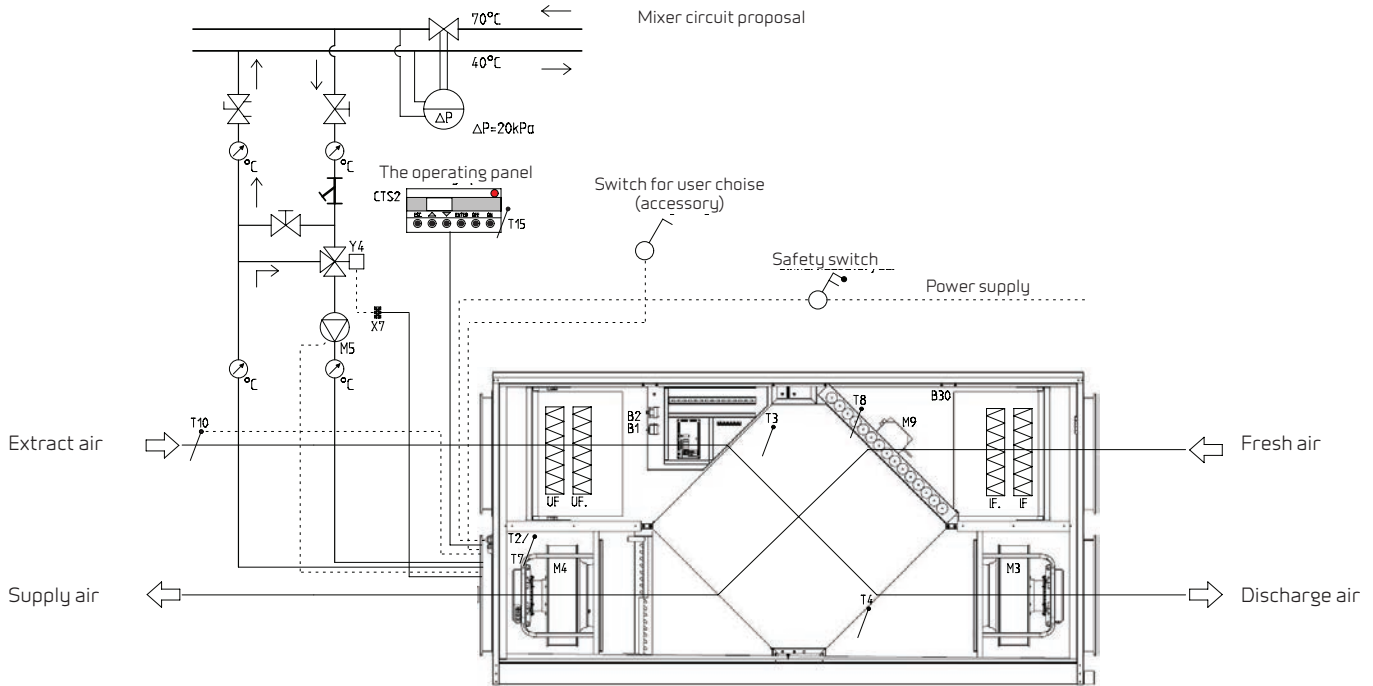

- T2/T7: Supply air sensor
- T9: Heating element frost protection
- T3: Extract air sensor
- T4: Discharge air and defrost sensor
- T8: Fresh air sensor
- T10: Room sensor

Electrical heating element (duct mounted)

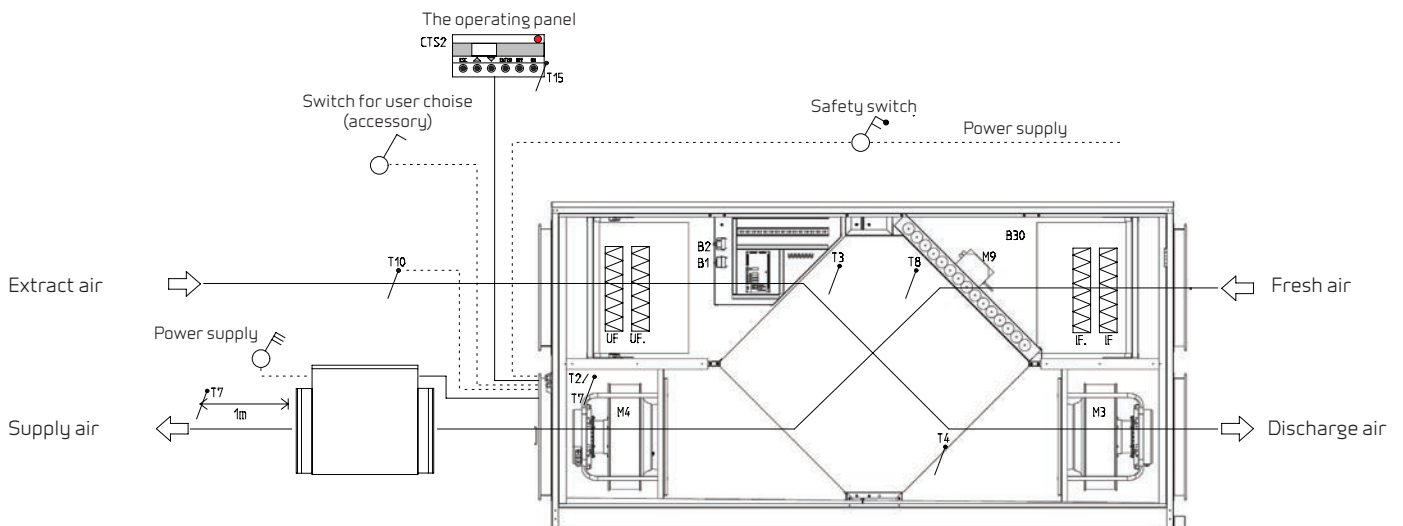

Capacity - Heating element (accessory)



Electrical heating surface

The electrical heating surface is fitted in the air inlet duct and connected to the CTS 602 control panel and 3 x 400 V supply.

The electrical heating surface can supply up to 15 kW or 21 kW of heat.



Water heating element for internal fitting

The water heating element is designed to be built into the system and must be connected to the primary heating supply and the CTS 602 control. The water heating element includes copper pipes and aluminium fins.

Capacities can be seen in the table below.

Capacity water heating element

Temperature input/output [°C]	Water side			Air side			
	Flow [l/h]	Pressure drop [kPa]	Output [kW]	Flow [m³/h]	Temperature before WHE* [°C]	Temperature after WHE* [°C]	Pressure drop over WHE* [Pa]
40/30	415	1.7	4.8	1000	16	30.1	3
	672	4.1	7.8	2000	16	27.4	9
	871	6.5	10.1	3000	16	25.8	18
	1036	9.0	12.0	4000	16	24.8	29
	1178	11.4	13.7	5000	16	24.0	41
60/40	379	1.4	8.7	1000	16	41.6	3
	612	3.3	14.1	2000	16	36.6	9
	792	5.2	18.2	3000	16	33.8	18
	941	7.2	21.7	4000	16	31.9	29
	1070	9.1	24.7	5000	16	30.4	41
70/40	285	0.8	9.8	1000	16	44.8	3
	455	1.9	15.7	2000	16	39.0	9
	586	3.0	20.2	3000	16	35.7	18
	694	4.0	23.9	4000	16	33.5	29
	786	5.1	27.1	5000	16	31.9	41

* Water heating element.

AUTOMATION

CTS602 Control



The Comfort 5000 is controlled using its CTS 602 operating panel, featuring a wide range of functions, e.g., menu-controlled operation, weekly programme settings, filter monitor with timer, fan speed adjustment, summer bypass (free cooling), post-heating element control, error messages etc.

The CTS 602 comes with factory settings, including a default setting which can be customised to operational requirements to achieve optimum operation and utilisation of the system.

The operating panel must be placed in a dry, frost-free location, at least 1.5 m above floor level and at least 0.5 m from any corner. Avoid placing the panel on an external wall or in areas in direct sunlight.

Operating instructions for the CTS 602 can be found in a separate user manual supplied with the unit.

External communication

The CTS 602 control unit communicates by default with Modbus RTU RS485 communication. A CTS system using this form of communication can easily be connected to the unit.

Nilan units have an open Modbus communication, i.e. not only can the unit be monitored, but its operation can also be set in the same way as it can via the operating panel.

The protocol is set up by default for a Modbus RTU 30 address, but can be set to a value between 1 and 247.

A Modbus converter allows you to connect one or more units to a computer to monitor and control the unit.

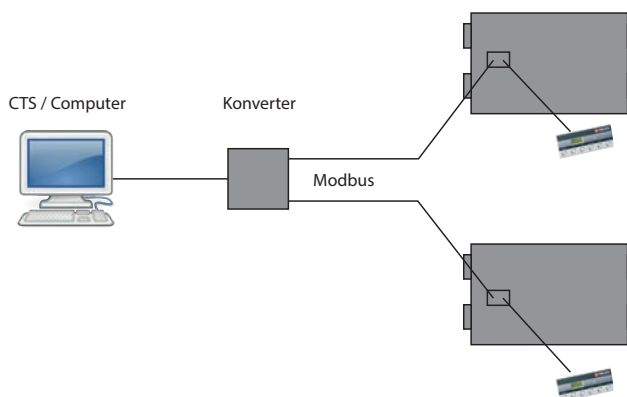

Functional overview		+ Standard - Accessories
3 levels	The control function is divided into 3 levels: User/Service/Factory with various options at each level	+
Weekly plan	There is an option for you to set your own weekly programme.	+
User option 1	This allows you to override the operating mode in the main menu via an external potential-free contact or PIR sensor.	+
Alarms	Alarm log featuring the last 16 alarms.	+
Filter monitor	Filter monitor with timer (factory setting of 90 days). Adjustable to 30/90/180/360 days.	+
Pressure controlled filter monitor	It is possible to purchase Comfort 1200 with a pressure controlled filter monitor	-
Bypass	Bypassing the outdoor air reduces heat recovery, enabling the desired supply air temperature to be maintained spring, summer and autumn.	+
Air quality	Allows you to choose whether to switch humidity sensors and/or CO ₂ sensors on and off.	-
Humidity control	Allows you to set a higher or lower ventilation step in the case of high/low air humidity.	-
CO ₂ control	Allows you to set a higher or lower ventilation step in the case of a high/low CO ₂ level.	-
Air exchange	Allows you to select a low ventilation step in the case of low outside temperatures and air humidity.	+
Defrost function	Temperature-based automatic function for defrosting the heat exchanger.	+
Frostprotection	In case of failing heating system, the unit is turned off to avoid further cooling with a risk of the water heating coil frost bursting.	+
Temperature control	Allows you to select the temperature sensor which will control the unit. <ul style="list-style-type: none"> • T15 ROOM (panel sensor) • T10 EXT (fitted in a representative extraction valve) • T3 EXTRACT (extract air) 	+/-
Room low	Stops the unit at a low room temperature. Hereby is cooling of the home avoided in case of a failing central heating system. Standard set to OFF. Can be set from 1 to 20 degrees and is controlled by: <ul style="list-style-type: none"> • T15 ROOM (panel sensor) • T10 EXT (fitted in a representative extraction valve) • T3 EXHAUST (extract air) 	+
Room control	Allows you to set the regulator to control the room temperature.	+
Air volume	Allows you to set four ventilation steps. Supply air and extract air are set individually. Step 1 < 25% - Step 2 < 45% - Step 3 < 70% - Step 4 < 100%	+
Fire alarm	This allows you to connect fire-detecting thermostats, smoke detectors and other fire alarm contacts. In case of an alarm, smoke dampers are closed and the unit stops.	+
Joint alarm	Outlet for joint alarm	+
Constant pressure control	Allows control from both the extract air and supply air side.	-
Cooling	Via bypass. This allows you to choose whether to run the system at a higher or the highest ventilation step during cooling. The weekly programme has an option for setting cooling at night.	+
Intake air control	Allows you to set the regulator to control the intake air temperature/supply air (only available if the control unit has been configured for a supply-heating element).	+
External heating element	<ul style="list-style-type: none"> • Temperature sensor T7 is an supply air sensor • Integrated frost protection for external water heating element • Motorised valve and circulation pump control unit 	-
External electric heating element	<ul style="list-style-type: none"> • Temperature sensor T7 is an supply air sensor • Overheating protection 	-
Delayed start-up	There is a possibility for a delayed start-up by the fans, when a closing damper is installed.	+
Expansion PCB	Allows you to make additional connections, e.g. <ul style="list-style-type: none"> • User option 2 overrides User option 1 • Up to 500 W direct • Can give the signal for external heating if the defrost function is used • Switching the central heating system on/off 	-
Reset	Allows you to restore the factory settings.	+
Manual test	Allows you to test the unit's functions manually.	+
Language	Option for setting the relevant language (Danish/Finnish/Norwegian/Swedish/German/English/French).	+

OPERATION

Frost protection

All ventilation units with a counterflow heat exchanger will ice up if the outdoor temperature is below freezing for a prolonged period.

The extracted air condenses when it is cooled down during heat recovery. The high temperature efficiency will slowly turn the condensate to ice, which will block up the counterflow heat exchanger unless action is taken to remedy this.

Consideration must be given to whether the unit's operation can be protected during a lengthy period of frost or whether it is acceptable to decrease its operation.

In homes which are occupied at night, it would be advisable to protect the unit against frost when the outdoor temperature is coldest by using a pre-heating element. On the other hand, if the ventilation is for an office, it may be acceptable to decrease the operating level at night.

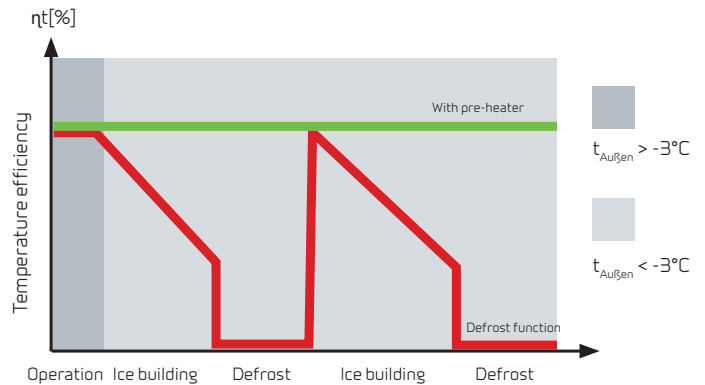

The energy used for the preheating is not wasted, as it ensures a constant high temperature efficiency

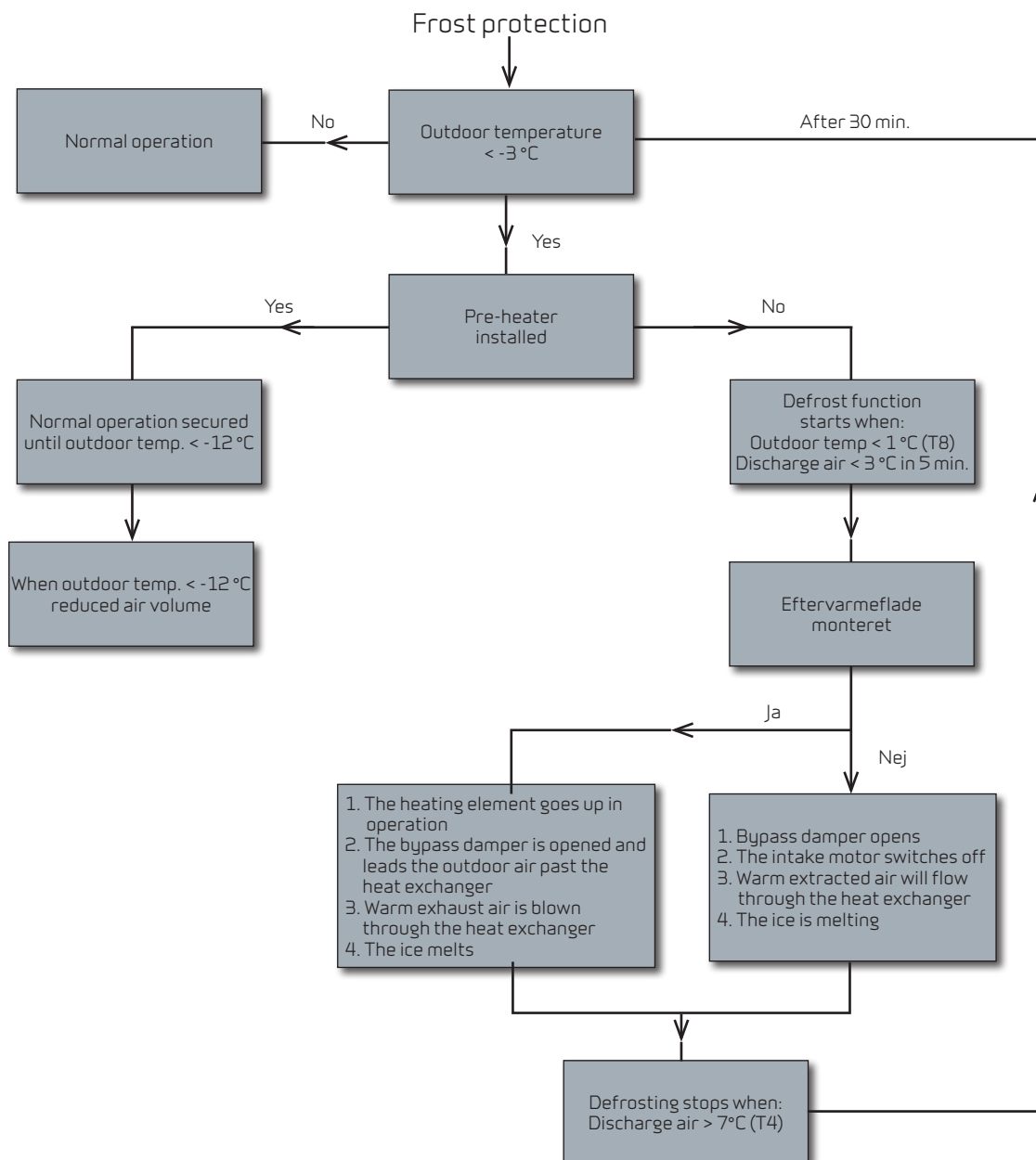

DIMENSIONAL DRAWING

COMFORT 5000 BY NILAN

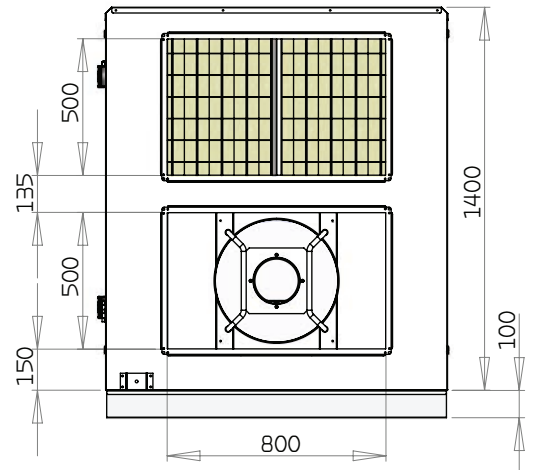
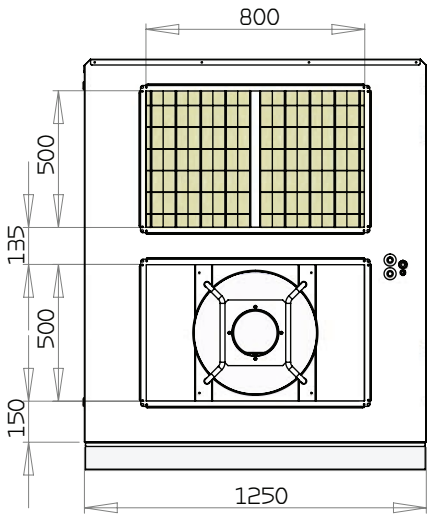
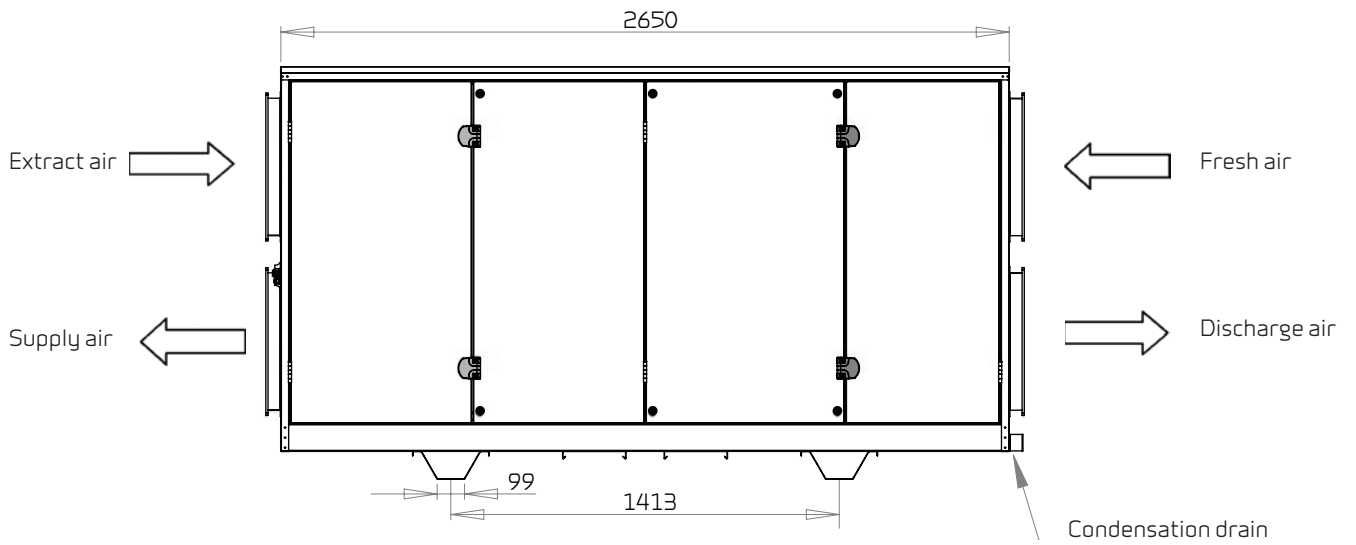

ACCESSORIES

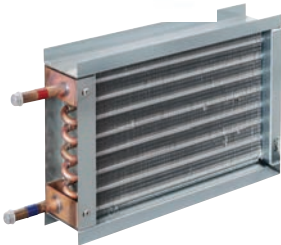

Pressure transmitter

The extraction and/or supply fan can be operated with the aid of one or two pressure transmitters.

Water heating element incl. regulation

The water heating element is designed to be built into the unit and must be connected to the primary heating supply. Supplied with three-way adjustment valve, temperature sensor and frost thermostat.

Electrical heating surface incl. regulation

The electrical heating surface is supplied ready to fit into the fresh air duct and, for easy fitting, the device is pre-fitted with all the required sensors. (15 kW or 21 kW)

Electrical pre-heating element (Frost protection)

Avoid having to defrost the unit, resulting in a loss of power. With temperature sensors supplied to be fitted in the ducts. (21 kW)

Top cover

If Comfort 5000 is going to be installed outside, it is possible to order a top cover which protects the unit against rain and snow.

Shut-off damper

Damper for external installation with or without spring-return.

Humidity- and CO₂-sensor

For demand control ventilation the unit can be integrated with an humidity- and CO₂-sensor.



Expansion PCB

The expansion PCB provides additional functions for the CTS 602 control.



Vibration dampers

A set of four vibration dampers can be included.

Water trap

The water seal is intended for negative pressure and has a ball to ensure that the water seal is tight even when not filled with water.

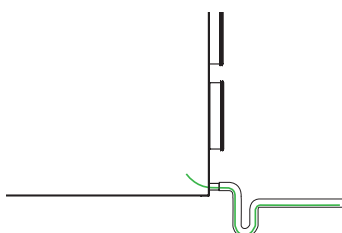

Heating cable

To protect the condensation outlet against frost, a 3 metre-long self-regulating heating cable can be ordered.

Pressure-regulated filter alarm

Measures the pressure drop across the filter and alerts when the filter is to be replaced.

DELIVERY AND HANDLING

Transport and storage

Comfort 1200 comes in factory packaging that protects it during transport and storage. Comfort 1200 must be stored in a dry place in its original packaging until installation.

The packaging should only be removed immediately prior to installation.

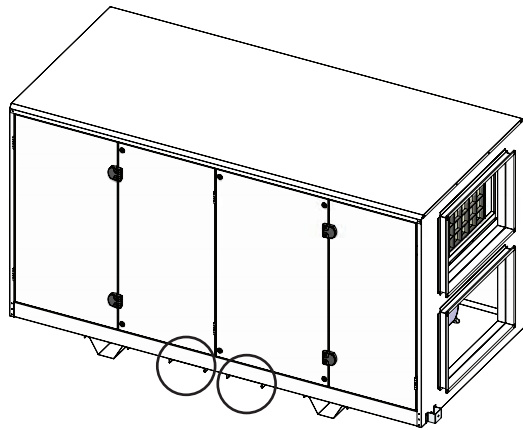

Handling and moving the Comfort 5000

Comfort 5000 is braced with two tracks at the bottom, which can be used to move the unit with a lifting truck.

Installation conditions

During installation, future service and maintenance should be taken into account. We recommend a minimum gap in front of the unit of 1 m.

The unit must be installed level for the sake of the condensate drain. The condensate drain requires clearance of min. 12,5 cm under the drain nozzle.

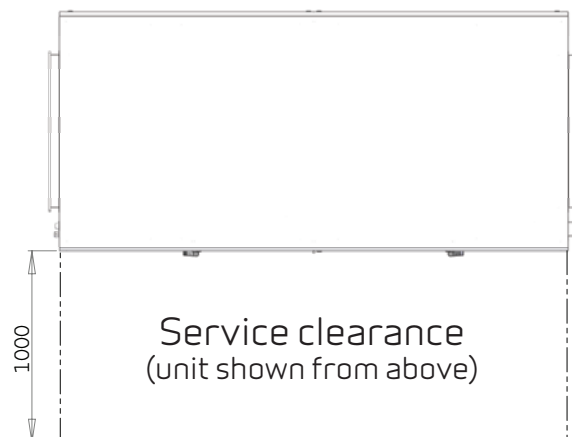

INFORMATION FROM A TO Z

Nilan develops and manufactures premium-quality, energy-saving ventilation and heat pump solutions that provide a healthy indoor climate and low-level energy consumption with the greatest consideration for the environment. In order to facilitate each step in the construction process - from choosing the solution through to planning, installation and maintenance - we have created a series of information material which is available for download at www.nilan.dk.



Brochure
General information about the solution and its benefits.



Product data
Technical information to ensure correct choice of solution.



Installation instructions
Detailed guide for installation and initial adjustment of the solution.



User manual
Detailed guide for regulation of the solution to ensure optimum day-to-day operation.

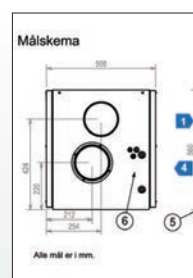

Drawings
Tender documents and 3D drawings are available to download for planning purposes.

WWW.NILAN.DK

Visit us at www.nilan.dk to find out more about our company and solutions, download further information and find your nearest dealer.



Nilan A/S
Nilanvej 2
8722 Hedensted
Danmark
Tlf. +45 76 75 25 00
Fax +45 76 75 25 25
nilan@nilan.dk
www.nilan.dk