

# PRODUCT DATA

COMFORT 600 BY NILAN



## Ventilation & passive heat recovery



Domestic



Passive  
heat recovery



Ventilation  
< 800 m<sup>3</sup>/h

# COMFORT 600

## Product description

The Comfort 600 is an energy-efficient ventilation unit with heat recovery for homes and smaller commercial buildings with a ventilation requirement of up to 800 m<sup>3</sup>/h.

This unit has been thoroughly tested, with improvements being continually made during its manufacture for more than 15 years. These have focused on low energy consumption, easy user operation and maintenance.

The Comfort 600 is a compact unit which can be ordered as a left- or right-handed model.

The Comfort 600 is factory tested and ready for use. Installation and commissioning must be performed by an authorised electrician.

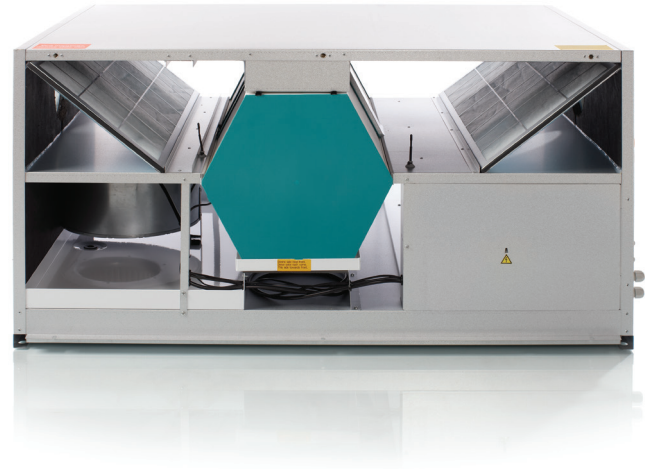

The large door provides easy access for changing filters and cleaning the unit.

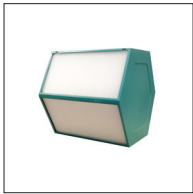

Counterflow heat exchanger made of polystyrene, which has a higher temperature efficiency than aluminium exchangers.



The unit comes with a clear and user-friendly operating panel.

The modern CTS 602 control panel runs Modbus communication.



The efficient fans are powered by energy-saving EC motors.

They provide a constant air volume with a four-step adjustment.



Prepared for an integrated or external water heating element.

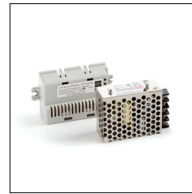

Intelligent humidity sensors provide an option for controlling the ventilation as required, based on the average air humidity in the home.

A CO<sub>2</sub> sensor can be purchased as an accessory.

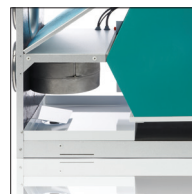

The powder-coated condensate drain prevents the formation of "acid water" and allows the condensate to be drained away.

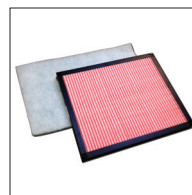

Filter monitor with timer

G4 filters are supplied as standard, but it is also possible to buy a F7 pollen filter as an accessory.

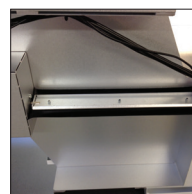

The automatic bypass damper makes the outdoor air bypass the heat exchanger when heat recovery is not required, thereby saving energy.

Bypass cooling as an option.

## Technical specifications

Dimensions (W x D x H)	1200 x 950 x 630 mm
Weight (*1)	101/75 kg
Plate type casing	Aluzinc steel plate
Heat loss casing (*2)	59 W/-59 W
Heat exchanger type	Polystyrene counterflow heat exchanger
Fan type	EC, constant volume
Filter class	Standard G4
Duct connections	Ø 200 mm
Condensate drain	PVC, Ø 20x1,5 mm
External leakage (*3)	< 0.1 %
Internal leakage (*4)	< 3.6 %

Supply voltage	230 V (±10 %), 50/60 HZ
Max. input/power (*5)	1145 W/7.1 A
Tightness class	IP31
Standby power	4 W
Power consumption (*5&6)	1220 kWh/år
Ambient temperature	-20/+40 °C

- \*1 75 kg is without side plates and exchanger.
- \*2 59 W: Outdoor air temperature -12 °C. Fitting location -12 °C. Extract air temperature 20 °C (room).  
-59 W: Outdoor air temperature -12 °C. Fitting location 20 °C. Extract air temperature 20 °C (room).
- \*3 At ± 250 Pa and 600 m<sup>3</sup>/h according EN 308/EN 13141-7.
- \*4 At ± 100 Pa and 600 m<sup>3</sup>/h according EN 308/EN 13141-7.
- \*5 Input without heating element (accessory).
- \*6 Power consumption on continuous operation for system with SFP value 1000 J/m<sup>3</sup> ved 500 m<sup>3</sup>/h.

## Dimensional drawing

Left model

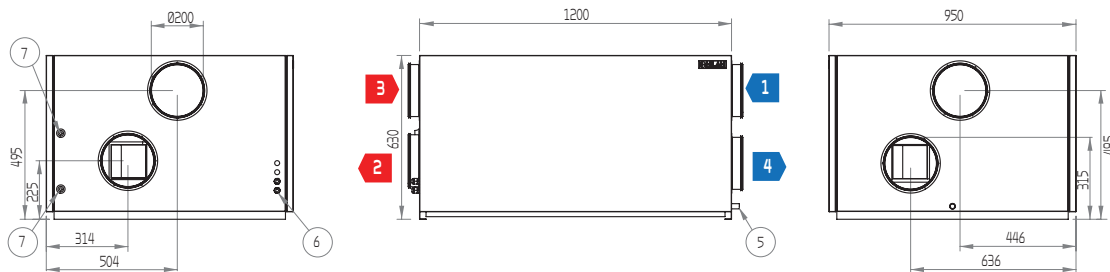

Right model

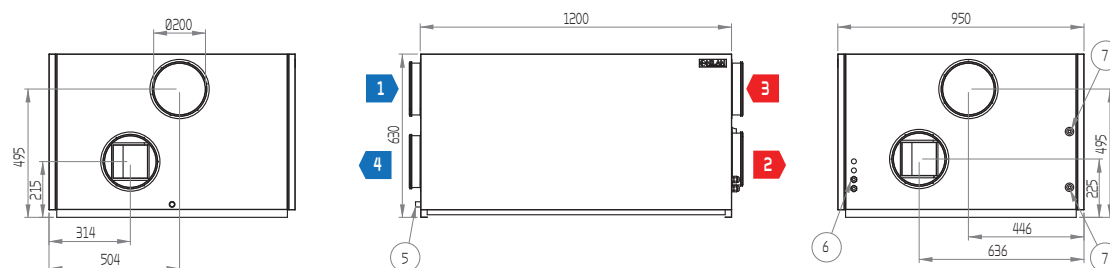

All dimensions are in mm

### Connections

- |                  |                                  |
|------------------|----------------------------------|
| 1: Fresh air     | 5: Condensate drain              |
| 2: Supply air    | 6: Electric and water heating    |
| 3: Extract air   | 7: Primary side (heat exchanger) |
| 4: Discharge air |                                  |

# PLANNING DATA

Nilan units are tested in accordance with the valid standards of accredited independent test institutes.

## Capacity

Capacity of standard unit as a function of  $q_v$  and  $P_{t,ext}$ .

SFP values according to EN 13141-7 are for standard units with G4 filters and no heating element.

SFP values comprise the unit's total power consumption incl. control.

Conversion factor:  $\frac{J/m^3}{3600} = W/m^3/h$

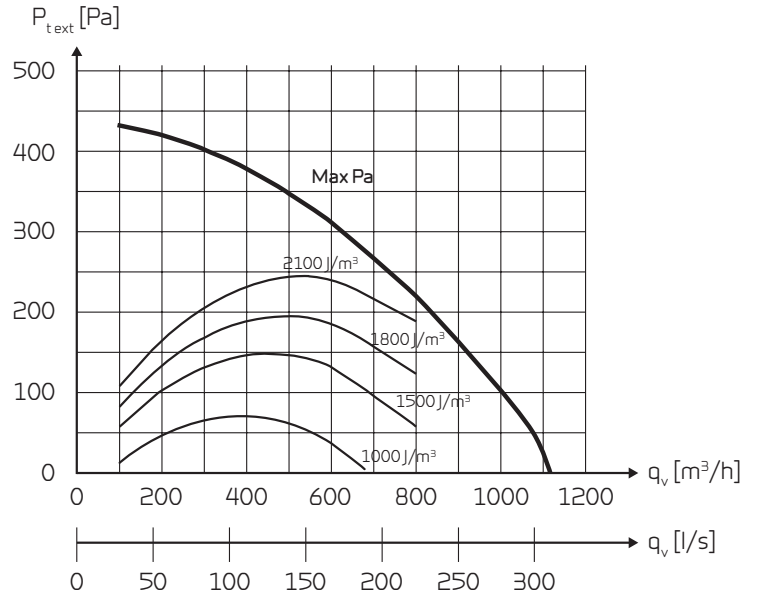

## Temperature efficiency

Temperature efficiency for units with counterflow heat exchanger according to EN308 (dry).

Temperature efficiency EN308:

$$\eta_t = (t_{\text{supply air}} - t_{\text{fresh air}}) / (t_{\text{extract air}} - t_{\text{fresh air}})$$

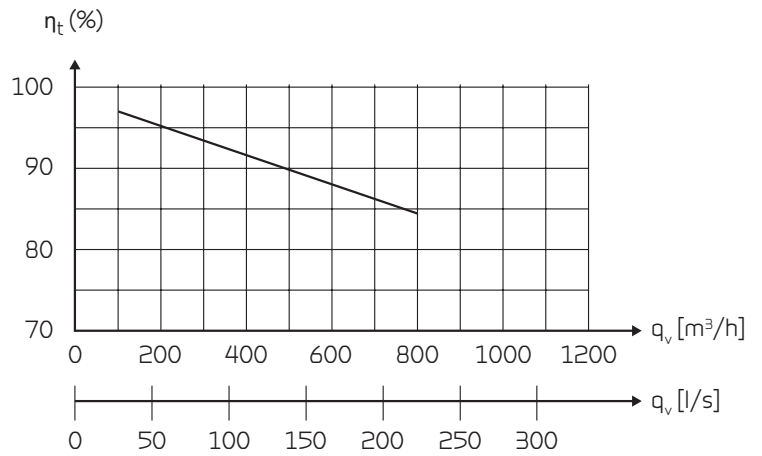

## Sound data

Sound data for  $q_v = 600 \text{ m}^3/h$  and  $P_{t,ext} = 100 \text{ Pa}$  according to EN 9614-2 for surfaces and EN 5136 for ducts.

Sound output level  $L_{WA}$  drops with falling air volume and falling back pressure.

Sound output level  $L_{pA}$  at a given distance will depend on acoustic conditions in the place of installation.

### Sound output level ( $L_{WA}$ )

Octave band Hz	Surface dB(A)	Supply air dB(A)	Extract air dB(A)
63	34	58	41
125	43	59	42
250	48	64	47
500	47	65	41
1000	53	67	31
2000	43	63	27
4000	38	60	17
8000	36	59	13
<b>Total ±2 dB(A)</b>	<b>55</b>	<b>72</b>	<b>50</b>

## Capacity - Heating element (accessory)



### Electrical heating surface

The electrical heating surface is fitted in the air inlet duct at a distance of min. 2 x duct diameter from the system's fresh air inlet connection pipe (normally min 400 mm.) and connected to the CTS 602 control panel and 230 V supply.

The electrical heating surface can supply up to 3,0 kW of heat.

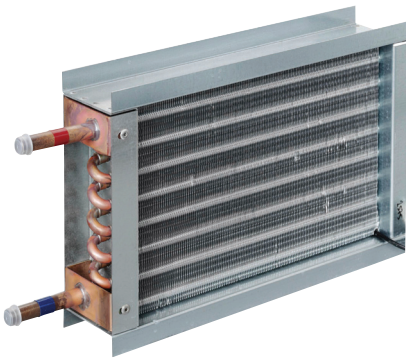

### Water heating element for internal fitting

The water heating element is designed to be built into the system and must be connected to the primary heating supply and the CTS 602 control. The water heating element includes copper pipes and aluminium fins.

Capacities can be seen in the table below.

### Capacity water heating element

Temperature input/output [°C]	Water side			Air side			
	Flow [m³/h]	Pressure drop [kPa]	Output [kW]	Flow [m³/h]	Temperature before WHE* [°C]	Temperature after WHE* [°C]	Pressure drop over WHE* [Pa]
40/30	0.1	0.74	1.1	200	16	32.2	2
	0.12	1.11	1.4	270	16	30.9	3
	0.16	2.1	1.9	420	16	29.2	4
	0.21	3.2	2.5	620	16	27.7	8
60/40	0.09	0.6	2	200	16	45.4	2
	0.11	0.9	2.5	270	16	43.1	3
	0.15	1.6	3.4	420	16	40	4
	0.2	2.5	4.5	620	16	37.2	8
70/40	0.07	0.36	2.3	200	16	49.4	2
	0.08	0.53	2.8	270	16	46.6	3
	0.11	0.92	3.9	420	16	42.9	4
	0.14	1.47	5	620	16	39.6	8

\* Water heating element.

# AUTOMATION

## CTS602 Control



The Comfort 600 is controlled using its CTS 602 operating panel, featuring a wide range of functions, e.g., menu-controlled operation, weekly programme settings, filter monitor with timer, fan speed adjustment, summer bypass (free cooling), post-heating element control, error messages etc.

The CTS 602 comes with factory settings, including a default setting which can be customised to operational requirements to achieve optimum operation and utilisation of the system.

The operating panel must be placed in a dry, frost-free location, at least 1.5 m above floor level and at least 0.5 m from any corner. Avoid placing the panel on an external wall or in areas in direct sunlight.

Operating instructions for the CTS 602 can be found in a separate user manual supplied with the unit.

## Functional diagram

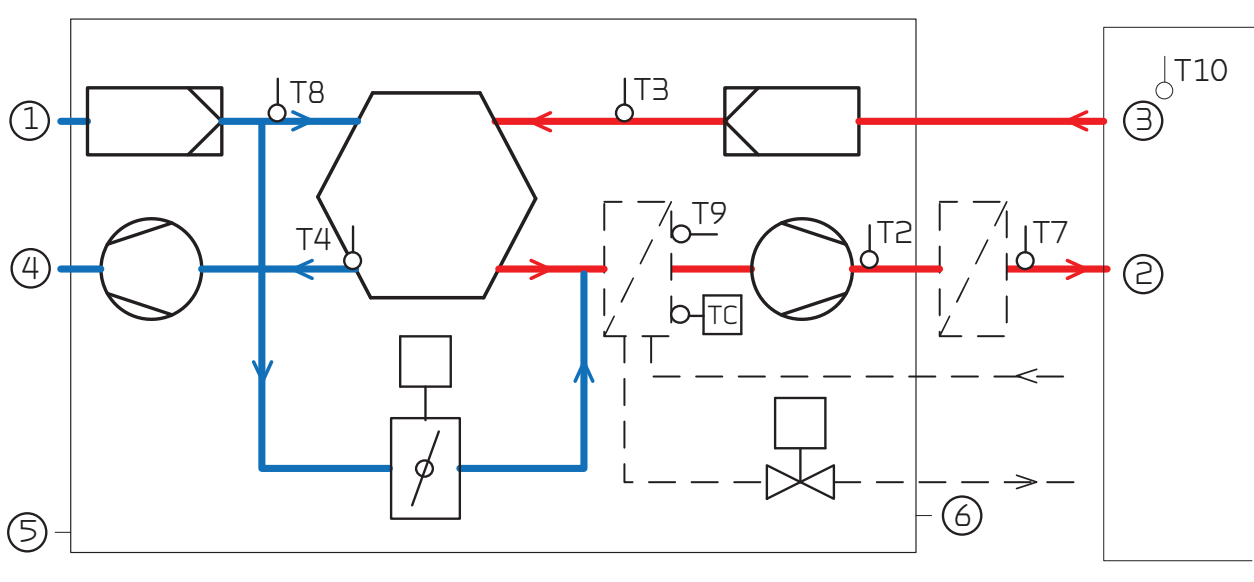

### Connections

- 1: Fresh air
- 2: Supply air
- 3: Extract air
- 4: Discharge air
- 5: Condensate drain
- 6: Electric and water heating

### Automation

- T2/T7: Supply air sensor
- T9/TC: Heating element frost protection
- T3: Extract air sensor
- T4: Discharge air and defrost sensor
- T8: Fresh air sensor
- T10: Room sensor

Functional overview		+ Standard - Accessories
3 levels	The control function is divided into 3 levels: User/Service/Factory with various options at each level	+
Weekly plan	The unit has 3 weekly programmes (with a factory setting of "off") <ul style="list-style-type: none"> <li>• Programme 1: for working families</li> <li>• Programme 2: for stay-at-home families</li> <li>• Programme 3: for businesses</li> </ul> There is also an option for you to set your own weekly programme.	+
User option 1	This allows you to override the operating mode in the main menu via an external potential-free contact or PIR sensor.	+
Alarms	Alarm log featuring the last 16 alarms.	+
Filter monitor	Filter monitor with timer (factory setting of 90 days). Adjustable to 30/90/180/360 days.	+
Bypass	Bypassing the outdoor air reduces heat recovery, enabling the desired supply air temperature to be maintained spring, summer and autumn.	+
Air quality	Allows you to choose whether to switch humidity sensors and/or CO <sub>2</sub> sensors on and off.	+/-
Humidity control	Allows you to set a higher or lower ventilation step in the case of high/low air humidity.	+
CO <sub>2</sub> control	Allows you to set a higher or lower ventilation step in the case of a high/low CO <sub>2</sub> level.	-
Air exchange	Allows you to select a low ventilation step in the case of low outside temperatures and air humidity.	+
Defrost function	Temperature-based automatic function for defrosting the heat exchanger.	+
Frostprotection	In case of failing heating system, the unit is turned off to avoid further cooling with a risk of the water heating coil frost bursting.	+
Temperature control	Allows you to select the temperature sensor which will control the unit. <ul style="list-style-type: none"> <li>• T15 ROOM (panel sensor)</li> <li>• T10 EXT (fitted in a representative extraction valve)</li> <li>• T3 EXHAUST (extract air)</li> </ul>	+
Room low	Stops the unit at a low room temperature. Hereby is cooling of the home avoided in case of a failing central heating system. Standard set to OFF. Can be set from 1 to 20 degrees and is controlled by: <ul style="list-style-type: none"> <li>• T15 ROOM (panel sensor)</li> <li>• T10 EXT (fitted in a representative extraction valve)</li> <li>• T3 EXHAUST (extract air)</li> </ul>	+
Room control	Allows you to set the regulator to control the room temperature.	+
Air volume	Allows you to set four ventilation steps. Supply air and extract air are set individually. Step 1 < 25% - Step 2 < 45% - Step 3 < 70% - Step 4 < 100%	+
Fire alarm	This allows you to connect fire-detecting thermostats, smoke detectors and other fire alarm contacts. In case of an alarm, smoke dampers are closed and the unit stops.	+
Joint alarm	Outlet for joint alarm	+
Constant pressure control	Allows control from both the extract air and supply air side.	-
Cooling	Via bypass. This allows you to choose whether to run the system at a higher or the highest ventilation step during cooling. The weekly programme has an option for setting cooling at night.	+
Intake air control	Allows you to set the regulator to control the intake air temperature/supply air (only available if the control unit has been configured for a supply-heating element).	+
External heating element	<ul style="list-style-type: none"> <li>• Temperature sensor T7 is an supply air sensor</li> <li>• Integrated frost protection for external water heating element</li> <li>• Motorised valve and circulation pump control unit</li> </ul>	-
External electric heating element	<ul style="list-style-type: none"> <li>• Temperature sensor T7 is an supply air sensor</li> <li>• Overheating protection</li> </ul>	-
Delayed start-up	There is a possibility for a delayed start-up by the fans, when a closing damper is installed.	+
Expansion PCB	Allows you to make additional connections, e.g. <ul style="list-style-type: none"> <li>• User option 2 overrides User option 1 (e.g. connecting an EM box)</li> <li>• Up to 500 W direct</li> <li>• Can give the signal for external heating if the defrost function is used</li> <li>• Switching the central heating system on/off</li> </ul>	-
Reset	Allows you to restore the factory settings.	+
Manual test	Allows you to test the unit's functions manually.	+
Language	Option for setting the relevant language (Danish/Finnish/Norwegian/Swedish/German/English/French).	+

# COMMUNICATION

## External communication

The CTS 602 control unit communicates by default with Modbus RTU RS485 communication. A CTS system using this form of communication can easily be connected to the unit.

Nilan units have an open Modbus communication, i.e. not only can the unit be monitored, but its operation can also be set in the same way as it can via the operating panel.

The protocol is set up by default for a Modbus RTU 30 address, but can be set to a value between 1 and 247.

A Modbus converter allows you to connect one or more units to a computer to monitor and control the unit.

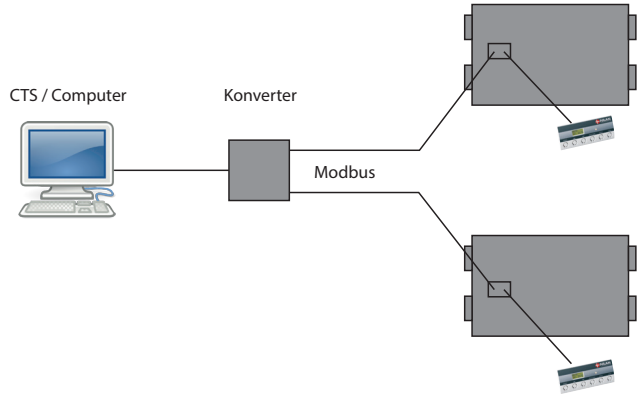

# OPERATION

## Intelligent humidity control

Nilan's humidity control automatically adapts to the needs of the family or the building.

The intelligent CTS 602 control unit does not need to have a set level input for air humidity (RH) to control the air exchange. By using the integrated humidity sensor, the control unit calculates the average level itself for the last 24 hours. The average level provides a basis for deciding whether to change the air exchange if the air humidity fluctuates.

This ensures that the unit always runs at its most efficient, based on the actual air humidity level and not on a theoretical one.

This helps save energy because it automatically adapts to the requirements in the home. Whether a large family or a single person is living in the building has a considerable influence on how much humidity is produced.

The unit also adjusts automatically to summer and winter level.

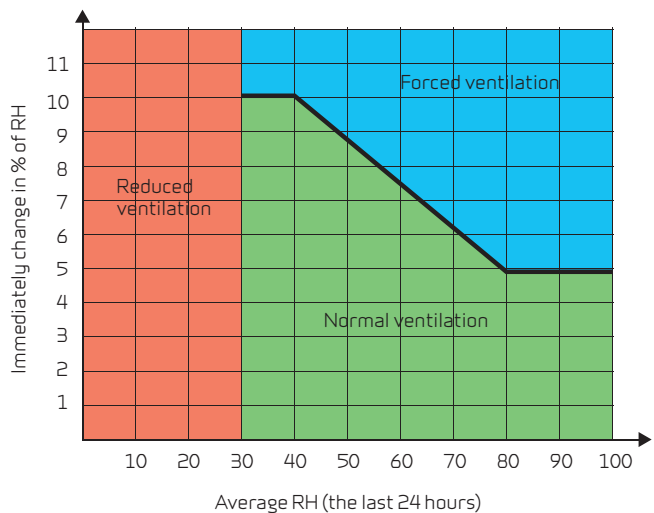

*If the air humidity changes by more than 5-10% in relation to the average level, the unit responds with a higher rate of air exchange accordingly.*

*At an air humidity below 30% is reduced ventilation step activated (adjustable between 15 and 45%)*



## Frost protection

All ventilation units with a counterflow heat exchanger will ice up if the outdoor temperature is below freezing for a prolonged period.

The extracted air condenses when it is cooled down during heat recovery. The high temperature efficiency will slowly turn the condensate to ice, which will block up the counterflow heat exchanger unless action is taken to remedy this.

Consideration must be given to whether the unit's operation can be protected during a lengthy period of frost or whether it is acceptable to decrease its operation.

In homes which are occupied at night, it would be advisable to protect the unit against frost when the outdoor temperature is coldest by using a pre-heating element. On the other hand, if the ventilation is for an office, it may be acceptable to decrease the operating level at night.

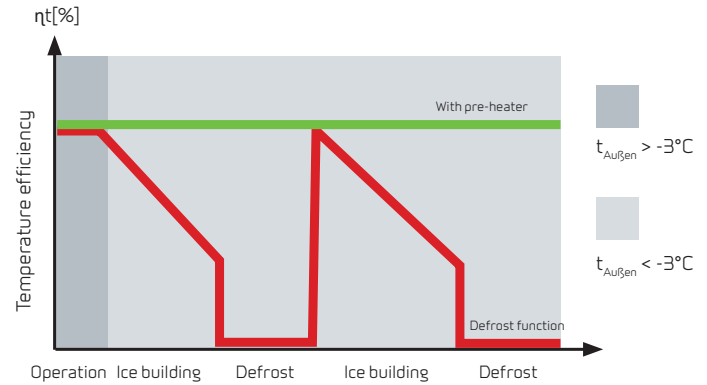

The energy used for the preheating is not wasted, as it ensures a constant high temperature efficiency

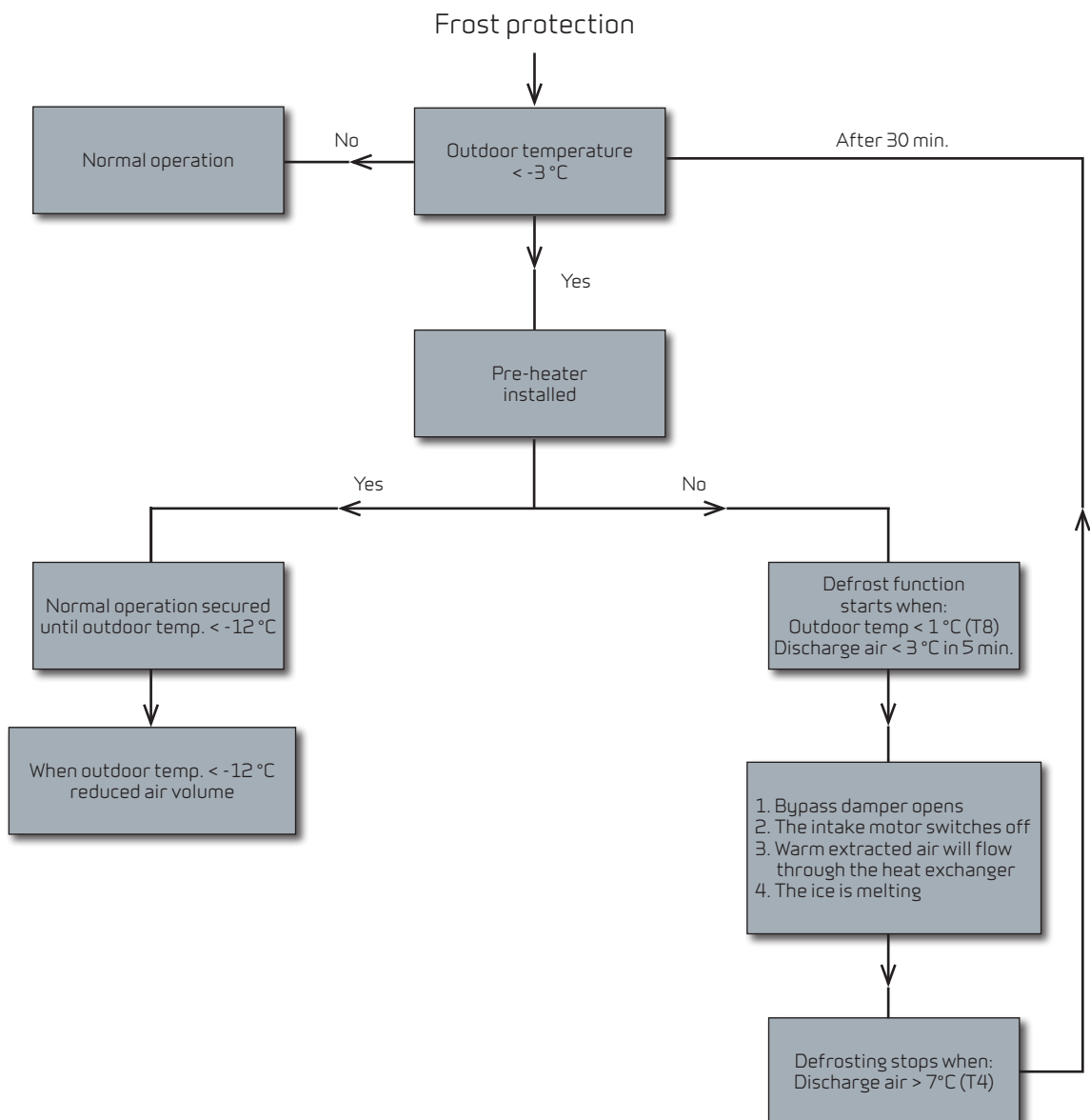

# ACCESSORIES



## CO<sub>2</sub>-sensor

With a CO<sub>2</sub>-sensor installed, the ventilation speed can be pre-programmed with CTS602 to run at a higher ventilation steps when CO<sub>2</sub> reaches high level in the extract air. CO<sub>2</sub>-level is programmable.

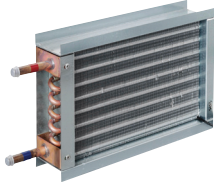

## Water heating element incl. regulation

The supply temperature can always be raised to the required level using a water heating element. The water heating element is designed to be built into the unit and must be connected to the primary heating supply. Supplied with two-way adjustment valve, temperature sensor and frost thermostat.



## Electrical heating surface incl. regulation

When you fit an electrical heating surface, you can raise the fresh air temperature to the desired level at any time. The electrical heating surface is supplied ready to fit into the fresh air duct and, for easy fitting, the device is pre-fitted with all the required sensors.



## Electrical pre-heating element (Frost protection)

An electrical pre-heating element heats up the outdoor air before it enters the unit. This avoids having to defrost the unit, resulting in a loss of power. There are temperature sensors supplied to be fitted in the ducts.



## EM-box

An EM-box allows heat recovery from the air from the range hood and thereby helps to heat the supply air. The EM-box is equipped with a special filter which efficiently cleans the range hood air of fat particles and thereby protects the system.



## Expansion PCB

The expansion PCB provides additional functions for the CTS 602 control unit, e.g., controlling the EM box (see list of functions on page 7).

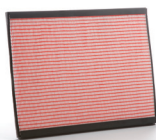

## Pollen filter F7

A pollen filter in class F7 can be fitted in the unit. The pollen filter is fitted with the G4 plate filter.

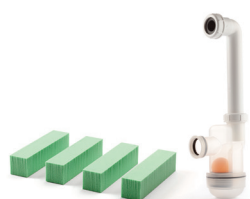

## Installation kit

The installation kit comprises of four vibration absorbers and a water trap for the condensation outlet. The water trap can be ordered separately.

## Heating cable

To protect the condensation outlet against frost, a 3 metre-long self-regulating heating cable can be ordered.

# DELIVERY AND HANDLING

## Transport and storage

Comfort 600 comes in factory packaging that protects it during transport and storage. Comfort 600 must be stored in a dry place in its original packaging until installation.

The packaging should only be removed immediately prior to installation.

## Installation conditions

During installation, future service and maintenance should be taken into account. We recommend a minimum gap in front of and behind the unit of 60 cm.

The unit must be installed level for the sake of the condensate drain. The condensate drain requires clearance of min. 12,5 cm under the drain nozzle.

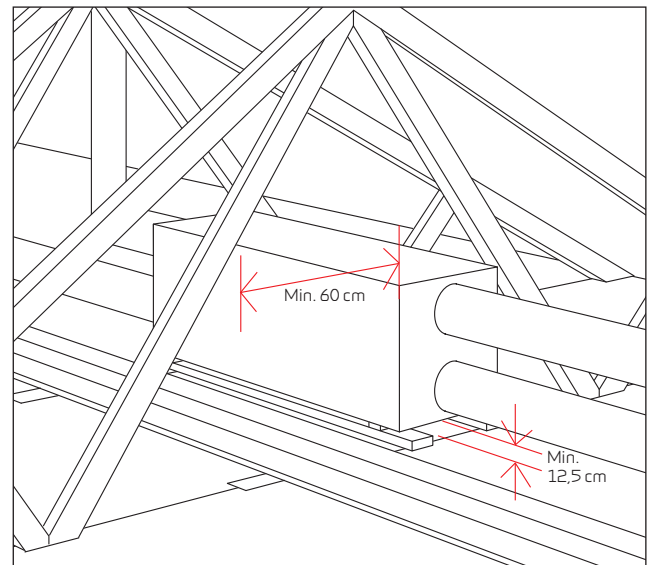

## Installation of electric heating element

Electric heating elements (accessories) are fitted in the duct. The fitter should ensure that there is a safe distance of at least 15 cm between the electric heating element and any inflammable material. The heating element must be insulated using fire-resistant insulation material.

The electric heating element must be connected by an authorised electrician.

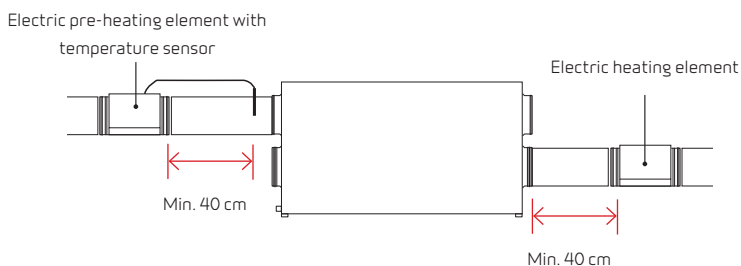
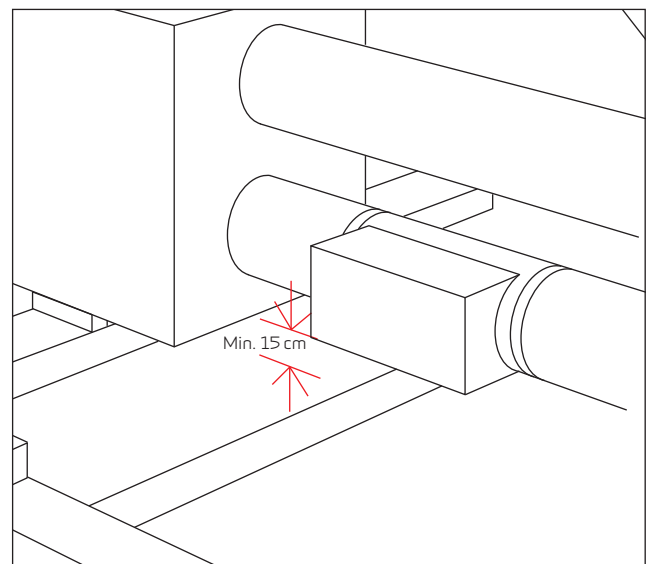

# INFORMATION FROM A TO Z

Nilan develops and manufactures premium-quality, energy-saving ventilation and heat pump solutions that provide a healthy indoor climate and low-level energy consumption with the greatest consideration for the environment. In order to facilitate each step in the construction process - from choosing the solution through to planning, installation and maintenance - we have created a series of information material which is available for download at [www.nilan.dk](http://www.nilan.dk).



**Brochure**  
General information about the solution and its benefits.



**Product data**  
Technical information to ensure correct choice of solution.

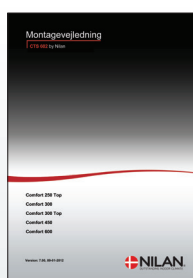

**Installation instructions**  
Detailed guide for installation and initial adjustment of the solution.



**User manual**  
Detailed guide for regulation of the solution to ensure optimum day-to-day operation.

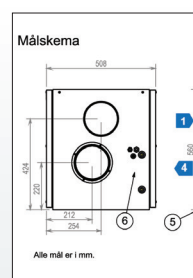

**Drawings**  
Tender documents and 3D drawings are available to download for planning purposes.

[WWW.NILAN.DK](http://WWW.NILAN.DK)

Visit us at [www.nilan.dk](http://www.nilan.dk) to find out more about our company and solutions, download further information and find your nearest dealer.



Nilan A/S  
Nilanvej 2  
8722 Hedensted  
Danmark  
Tlf. +45 76 75 25 00  
Fax +45 76 75 25 25  
[nilan@nilan.dk](mailto:nilan@nilan.dk)  
[www.nilan.dk](http://www.nilan.dk)